

Schottky Barrier Rectifier

SS52F ~ SS520F

■ Features

- Metal silicon junction, majority carrier conduction
- For surface mounted applications
- Low power loss, high efficiency
- High forward surge current capability
- For use in low voltage, high frequency inverters, free wheeling, and polarity protection applications

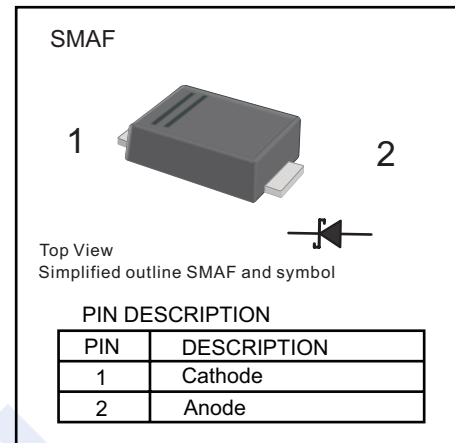

■ Absolute Maximum Ratings and Electrical characteristics

Ratings at 25°C ambient temperature unless otherwise specified. Single phase, half wave, 60Hz resistive or inductive load, for capacitive load, derate by 20 %

Parameter	Symbol	SS 52F	SS 54F	SS 56F	SS 58F	SS 510F	SS 512F	SS 515F	SS 520F	Unit	
Maximum Repetitive Peak Reverse Voltage	V_{RRM}	20	40	60	80	100	120	150	200	V	
Maximum RMS voltage	V_{RMS}	14	28	42	56	70	84	105	140		
Maximum DC Blocking Voltage	V_{DC}	20	40	60	80	100	120	150	200		
Maximum Average Forward Rectified Current	$I_{F(AV)}$	5.0								A	
Peak Forward Surge Current, 8.3ms Single Half Sine-wave Superimposed on Rated Load (JEDEC method)	I_{FSM}	120				100					
Max Instantaneous Forward Voltage at 5 A	V_F	0.55		0.7		0.85				V	
Maximum DC Reverse Current at rated DC blocking voltage	I_R	$T_a = 25^\circ\text{C}$ 1.0				$T_a = 100^\circ\text{C}$ 50				mA	
Typical Junction Capacitance *1	C_j	500			300					pF	
Typical thermal resistance *2	R_{thJA}	60									°C/W
Junction Temperature	T_j	150									°C
Storage Temperature	T_{stg}	-55 to 150									

* 1 Measured at 1MHz and applied reverse voltage of 4 V D.C

* 2 P.C.B. mounted with 2" × 2" (5×5 cm) copper pad areas.

Schottky Barrier Rectifier

SS52F ~ SS520F

■ Typical Characteristics

Fig.1 Forward Current Derating Curve

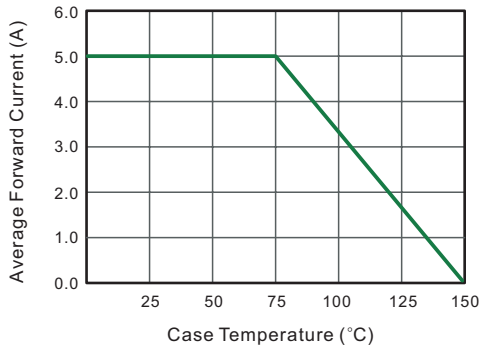

Fig.2 Typical Reverse Characteristics

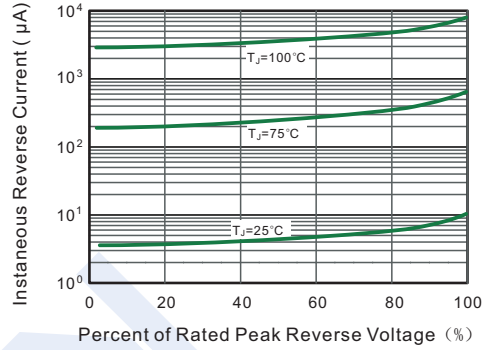

Fig.3 Typical Forward Characteristic

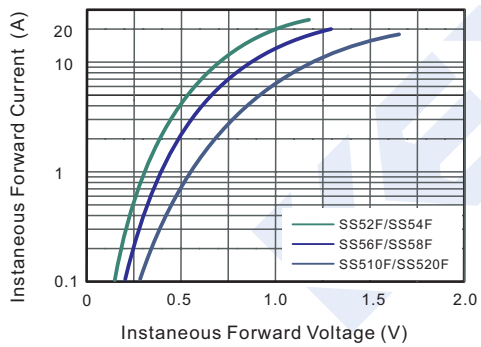

Fig.4 Typical Junction Capacitance

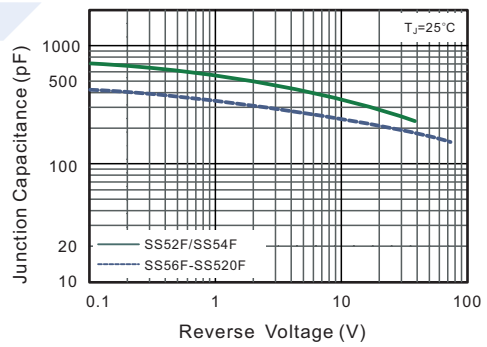

Fig.5 Maximum Non-Repetitive Peak Forward Surge Current

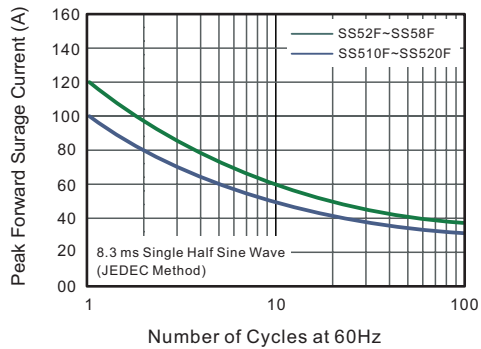
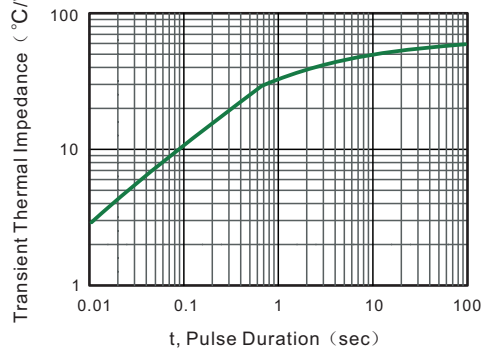

Fig.6- Typical Transient Thermal Impedance



Schottky Diodes SS52F ~ SS520F

■ Package Outline

Plastic surface mounted package; 2 leads

SMAF

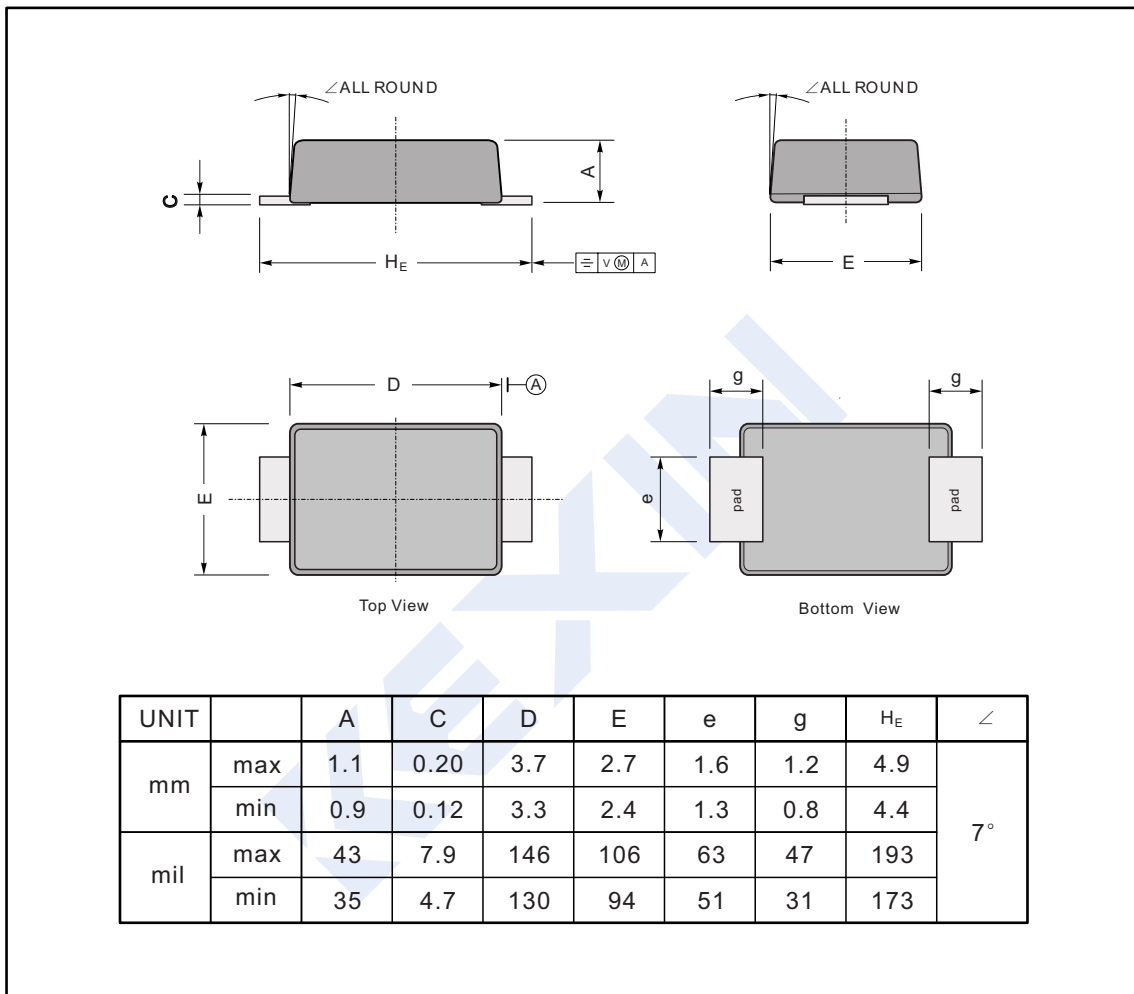

■ The recommended mounting pad size

