

Schottky Diodes

1KK2202B ~ 1KK2220B

■ Features

- Reverse Voltage - 20 to 200 V
- Forward Current - 2.0 A
- Metal silicon junction, majority carrier conduction
- For surface mounted applications
- Low power loss, high efficiency
- High forward surge current capability
- For use in low voltage, high frequency inverters, free wheeling, and polarity protection applications

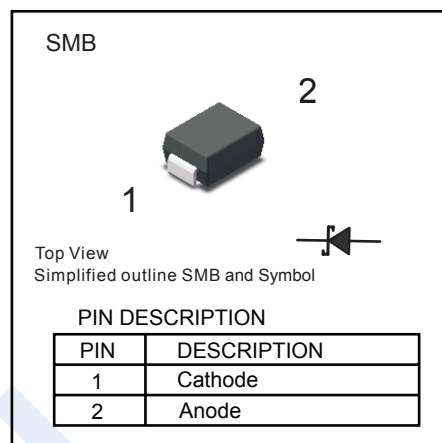

■ Absolute Maximum Ratings and Electrical characteristics

Ratings at 25°C ambient temperature unless otherwise specified.

Single phase half-wave 60 Hz, resistive or inductive load, for capacitive load current derate by 20 %.

Parameter	Symbols	1KK 2202B	1KK 2204B	1KK 2206B	1KK 2208B	1KK 2210B	1KK 2212B	1KK 2215B	1KK 2220B	Unit	
Maximum Repetitive Peak Reverse Voltage	V_{RRM}	20	40	60	80	100	120	150	200	V	
Maximum RMS voltage	V_{RMS}	14	28	42	56	70	84	105	140		
Maximum DC Blocking Voltage	V_{DC}	20	40	60	80	100	120	150	200		
Maximum Instantaneous Forward Voltage at 2A	V_F	0.55		0.70		0.85		0.95		A	
Maximum Averaged Forward Rectified Current	$I_{F(AV)}$	2.0									
Peak Forward Surge Current, 8.3 ms Single Half Sine Wave Superimposed on Rated Load	I_{FSM}	50									
Maximum DC Reverse Current $T_a=25^\circ\text{C}$ at rated DC blocking voltage $T_a=100^\circ\text{C}$	I_R	0.5			0.3			3			mA
Typical Junction Capacitance *1	C_j	220			80						pF
Typical Thermal Resistance *2	$R_{\theta JA}$	75									°C/W
Operating Junction Temperature Range	T_j	-55 ~ +125									°C
Storage Temperature Range	T_{stg}	-55 ~ +150									

* 1 Measured at 1MHz and applied reverse voltage of 4V D.C.

* 2 P.C.B. mounted with 2.0" × 2.0" (5×5 cm) copper pad areas.

■ Marking

NO.	1KK 2202B	1KK 2204B	1KK 2206B	1KK 2208B	1KK 2210B	1KK 2212B	1KK 2215B	1KK 2220B
Marking	2B02	2B04	2B06	2B08	2B10	2B12	2B15	2B20

Schottky Diodes

1KK2202B ~ 1KK2220B

■ Typical Characteristics

Fig.1 Forward Current Derating Curve

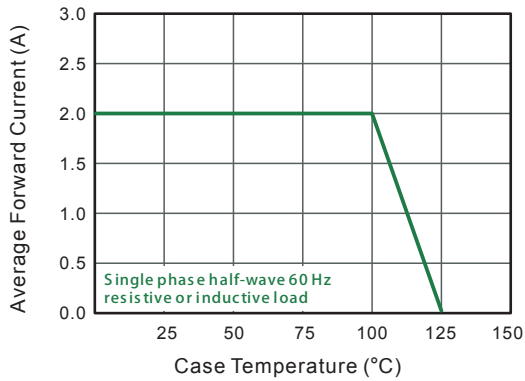

Fig.2 Typical Reverse Characteristics

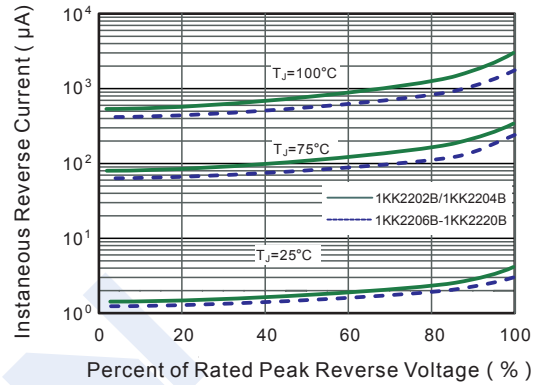

Fig.3 Typical Forward Characteristic

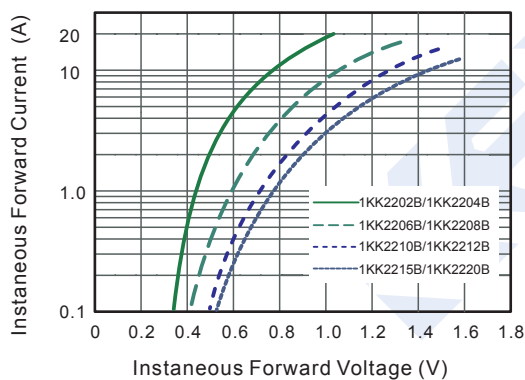

Fig.4 Typical Junction Capacitance

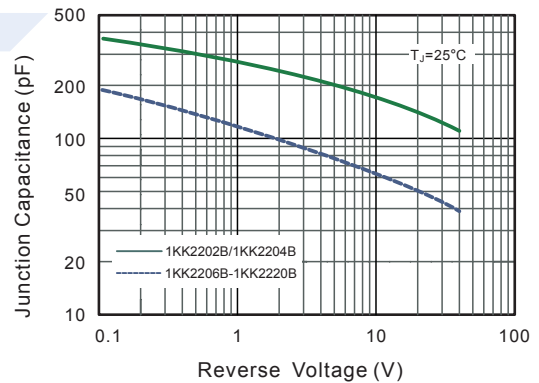

Fig.5 Maximum Non-Repetitive Peak Forward Surge Current

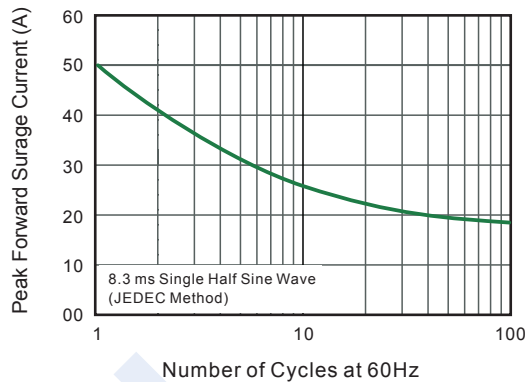
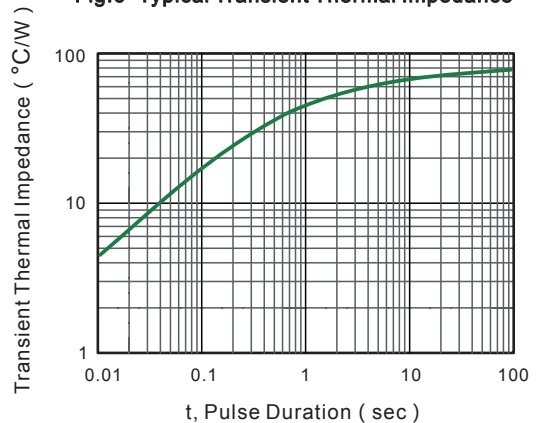

Fig.6- Typical Transient Thermal Impedance



Schottky Diodes

1KK2202B ~ 1KK2220B

■ Package Outline Dimensions

Plastic surface mounted package; 2 leads

SMB

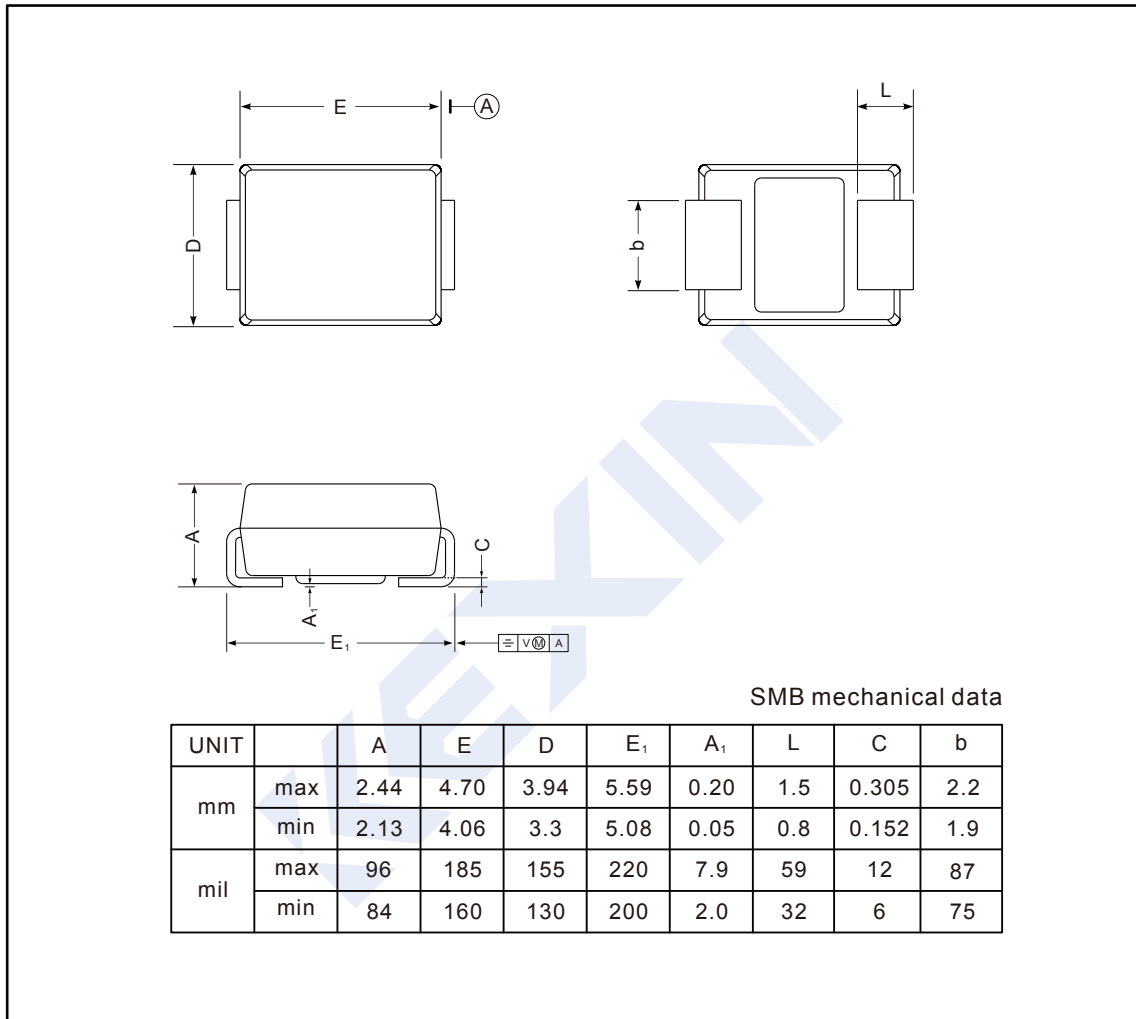

■ The Recommended Mounting Pad Size

